

A →

A-A (1 : 5)

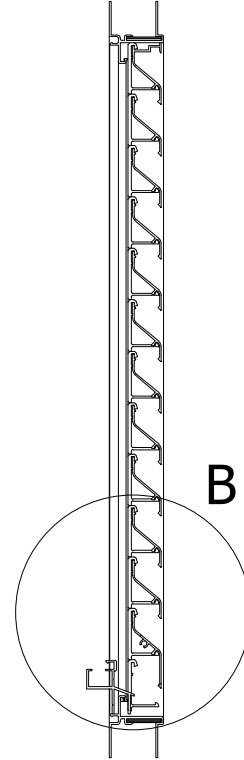

A →

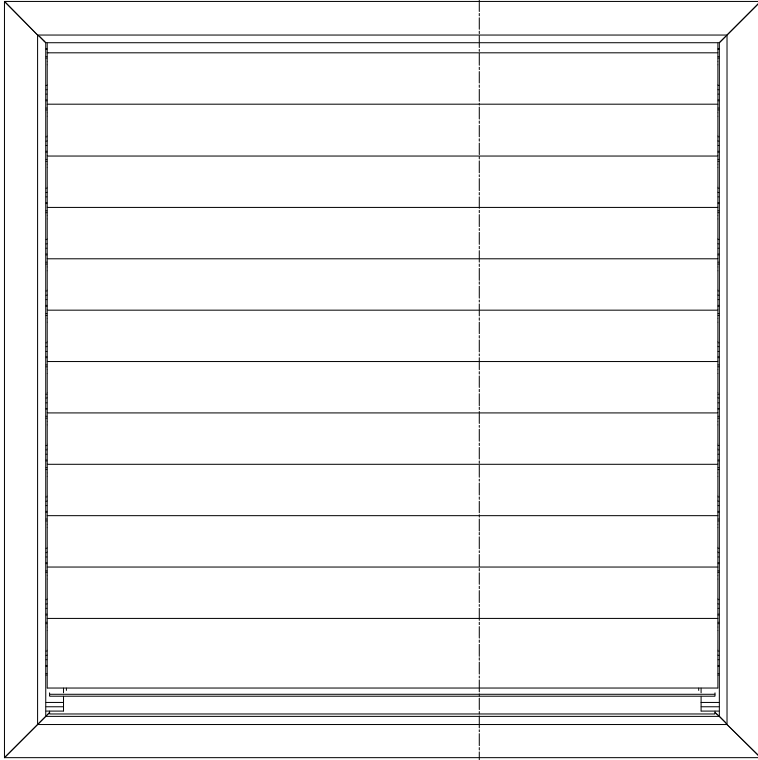
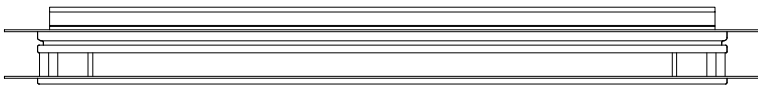

B (1 : 2)

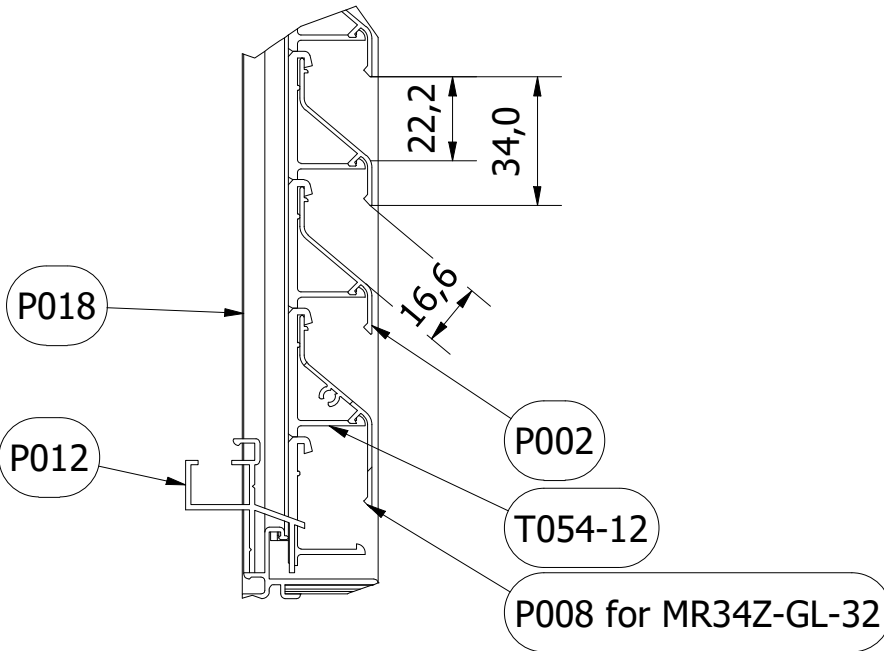
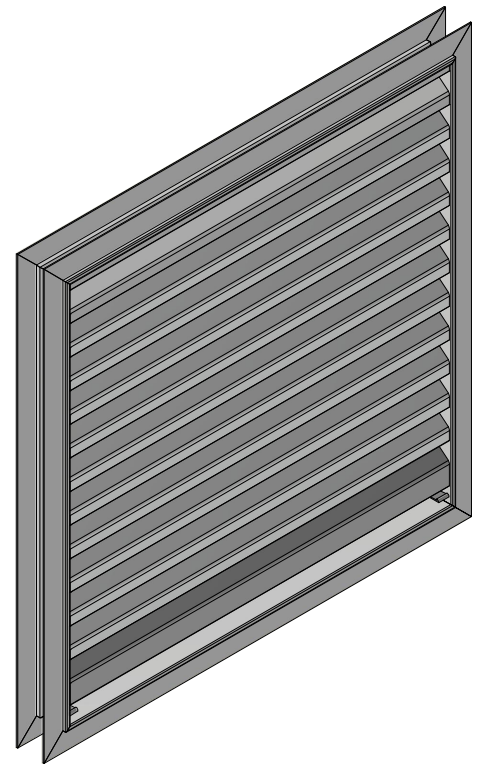

Name:				No MR34Z-GL-32 met lamel P002
Material	Weight N/A	Coating surface	Anodisation surface N/A	Page size: A4
				Scale: 1 : 5
		www.tunal.be Menensesteenweg 295 8940 Wervik	Tel. +32 56 67 15 80	Tol. DIN1748 (DEEL 4) Name: Serge Date: 1/12/2020