

A →

A-A ( 1 : 5 )

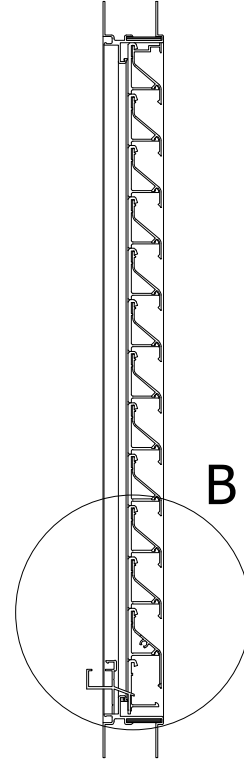

A →

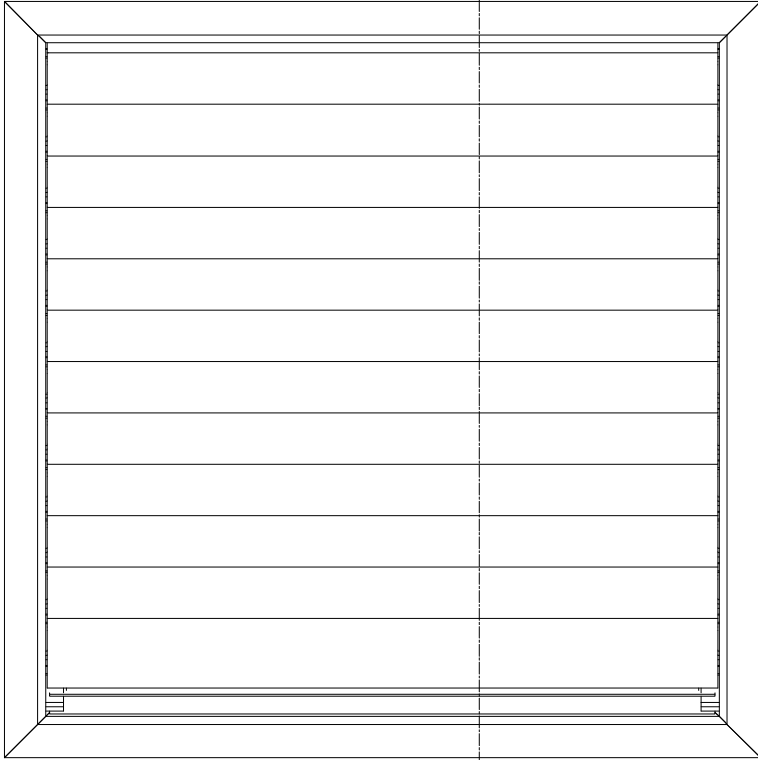
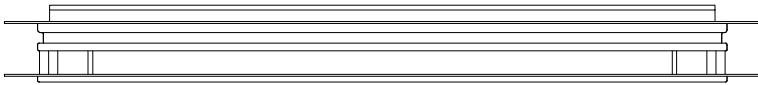

B ( 1 : 2 )

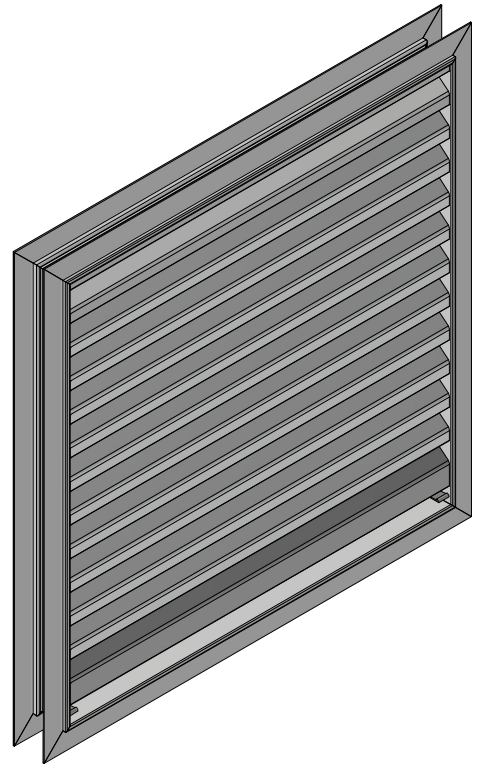
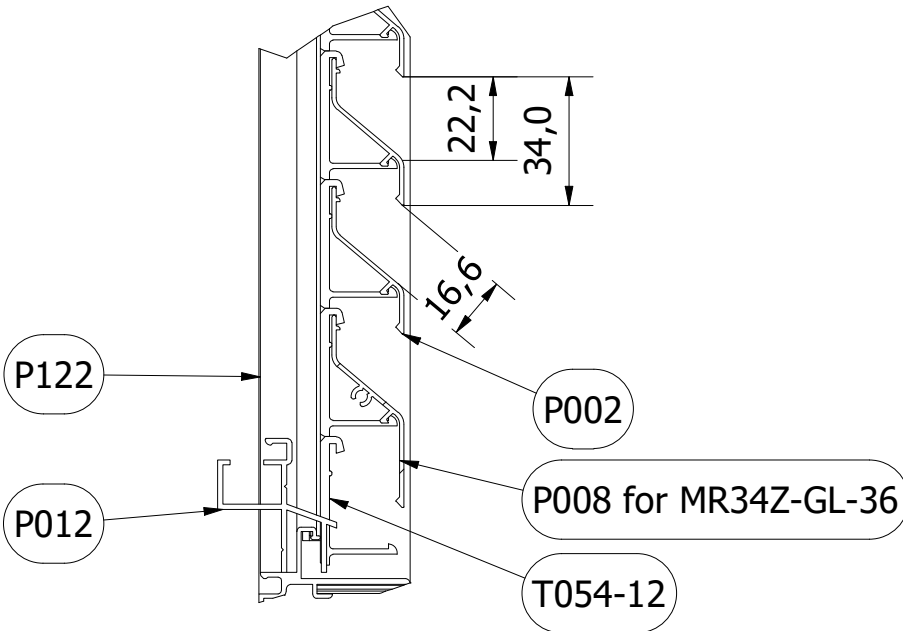

Name:				No MR34Z-GL-36 met lamel P002
Material	Weight N/A	Coating surface	Anodisation surface N/A	Page size: A4
				Scale: 1 : 5
		www.tunal.be Menensesteenweg 295 8940 Wervik	Tel. +32 56 67 15 80	Tol. DIN1748 (DEEL 4)
				Name: Serge Date: 1/12/2020